

## DTP Systems

# DTP T/R DP 4K 330

# DTP T/R DP 4K 230

DisplayPort Twisted Pair Extenders



**Extron Electronics**  
INTERFACING, SWITCHING AND CONTROL

# Safety Instructions

## Safety Instructions • English

**⚠ WARNING:** This symbol, , when used on the product, is intended to alert the user of the presence of uninsulated dangerous voltage within the product's enclosure that may present a risk of electric shock.

**ATTENTION:** This symbol, , when used on the product, is intended to alert the user of important operating and maintenance (servicing) instructions in the literature provided with the equipment.

For information on safety guidelines, regulatory compliances, EMI/EMF compatibility, accessibility, and related topics, see the Extron Safety and Regulatory Compliance Guide, part number 68-290-01, on the Extron website, [www.extron.com](http://www.extron.com).

## Sicherheitsanweisungen • Deutsch

**WARNUNG:** Dieses Symbol , auf dem Produkt soll den Benutzer darauf aufmerksam machen, dass im Inneren des Gehäuses dieses Produktes gefährliche Spannungen herrschen, die nicht isoliert sind und die einen elektrischen Schlag verursachen können.

**VORSICHT:** Dieses Symbol , auf dem Produkt soll dem Benutzer in der im Lieferumfang enthaltenen Dokumentation besonders wichtige Hinweise zur Bedienung und Wartung (Instandhaltung) geben.

Weitere Informationen über die Sicherheitsrichtlinien, Produkthandhabung, EMI/EMF-Kompatibilität, Zugänglichkeit und verwandte Themen finden Sie in den Extron-Richtlinien für Sicherheit und Handhabung (Artikelnummer 68-290-01) auf der Extron-Website, [www.extron.com](http://www.extron.com).

## Instrucciones de seguridad • Español

**ADVERTENCIA:** Este símbolo, , cuando se utiliza en el producto, avisa al usuario de la presencia de voltaje peligroso sin aislar dentro del producto, lo que puede representar un riesgo de descarga eléctrica.

**ATENCIÓN:** Este símbolo, , cuando se utiliza en el producto, avisa al usuario de la presencia de importantes instrucciones de uso y mantenimiento recogidas en la documentación proporcionada con el equipo.

Para obtener información sobre directrices de seguridad, cumplimiento de normativas, compatibilidad electromagnética, accesibilidad y temas relacionados, consulte la Guía de cumplimiento de normativas y seguridad de Extron, referencia 68-290-01, en el sitio Web de Extron, [www.extron.com](http://www.extron.com).

## Instructions de sécurité • Français

**AVERTISSEMENT :** Ce pictogramme, , lorsqu'il est utilisé sur le produit, signale à l'utilisateur la présence à l'intérieur du boîtier du produit d'une tension électrique dangereuse susceptible de provoquer un choc électrique.

**ATTENTION :** Ce pictogramme, , lorsqu'il est utilisé sur le produit, signale à l'utilisateur des instructions d'utilisation ou de maintenance importantes qui se trouvent dans la documentation fournie avec le matériel.

Pour en savoir plus sur les règles de sécurité, la conformité à la réglementation, la compatibilité EMI/EMF, l'accessibilité, et autres sujets connexes, lisez les informations de sécurité et de conformité Extron, réf. 68-290-01, sur le site Extron, [www.extron.com](http://www.extron.com).

## Istruzioni di sicurezza • Italiano

**AVVERTENZA:** Il simbolo, , se usato sul prodotto, serve ad avvertire l'utente della presenza di tensione non isolata pericolosa all'interno del contenitore del prodotto che può costituire un rischio di scosse elettriche.

**ATTENZIONE:** Il simbolo, , se usato sul prodotto, serve ad avvertire l'utente della presenza di importanti istruzioni di funzionamento e manutenzione nella documentazione fornita con l'apparecchio.

Per informazioni su parametri di sicurezza, conformità alle normative, compatibilità EMI/EMF, accessibilità e argomenti simili, fare riferimento alla Guida alla conformità normativa e di sicurezza di Extron, cod. articolo 68-290-01, sul sito web di Extron, [www.extron.com](http://www.extron.com).

## Instrukcja bezpieczeństwa • Polska

**OSTRZEŻENIE:** Ten symbol, , gdy używany na produkt, ma na celu poinformować użytkownika o obecności izolowanego i niebezpiecznego napięcia wewnątrz obudowy produktu, który może stanowić zagrożenie porażenia prądem elektrycznym.

**UWAGI:** Ten symbol, , gdy używany na produkt, jest przeznaczony do ostrzegania użytkownika ważne operacyjne oraz instrukcje konserwacji (obsługi) w literaturze, wyposażone w sprzęt.

Informacji na temat wytycznych w sprawie bezpieczeństwa, regulacji wzajemnej zgodności, zgodność EMI/EMF, dostępności i Tematy pokrewne, zobacz Extron bezpieczeństwa i regulacyjnego zgodności przewodnik, część numer 68-290-01, na stronie internetowej Extron, [www.extron.com](http://www.extron.com).

## Инструкция по технике безопасности • Русский

**ПРЕДУПРЕЖДЕНИЕ:** Данный символ, , если указан на продукте, предупреждает пользователя о наличии неизолированного опасного напряжения внутри корпуса продукта, которое может привести к поражению электрическим током.

**ВНИМАНИЕ:** Данный символ, , если указан на продукте, предупреждает пользователя о наличии важных инструкций по эксплуатации и обслуживанию в руководстве, прилагаемом к данному оборудованию.

Для получения информации о правилах техники безопасности, соблюдении нормативных требований, электромагнитной совместимости (ЭМП/ЭДС), возможности доступа и других вопросах см. руководство по безопасности и соблюдению нормативных требований Extron на сайте Extron: [www.extron.com](http://www.extron.com), номер по каталогу - 68-290-01.

## 安全说明 • 简体中文

**警告:** 产品上的这个标志意在警告用户该产品机壳内有暴露的危险电压, 有触电危险。

**注意:** 产品上的这个标志意在提示用户设备随附的用户手册中有重要的操作和维护(维修)说明。

关于我们产品的安全指南、遵循的规范、EMI/EMF 的兼容性、无障碍使用的特性等相关内容, 敬请访问 Extron 网站, [www.extron.com](http://www.extron.com), 参见 Extron 安全规范指南, 产品编号 68-290-01。

## 安全記事・繁體中文

**警告:** ⚠ 若產品上使用此符號, 是為了提醒使用者, 產品機殼內存在著可能會導致觸電之風險的未絕緣危險電壓。

**注意:** ⚠ 若產品上使用此符號, 是為了提醒使用者, 設備隨附的用戶手冊中有重要的操作和維護(維修)說明。

有關安全性指導方針、法規遵守、EMI/EMF 相容性、存取範圍和相關主題的詳細資訊, 請瀏覽 Extron 網站: [www.extron.com](http://www.extron.com), 然後參閱《Extron 安全性與法規遵守手冊》, 準則編號 68-290-01。

## 安全上のご注意・日本語

**警告:** この記号 ⚠ が製品上に表示されている場合は、筐体内に絶縁されていない高電圧が流れ、感電の危険があることを示しています。

**注意:** この記号 ⚠ が製品上に表示されている場合は、本機の取扱説明書に記載されている重要な操作と保守(整備)の指示についてユーザーの注意を喚起するものです。

安全上のご注意、法規遵守、EMI/EMF適合性、その他の関連項目については、エクストロンのウェブサイト [www.extron.com](http://www.extron.com) より『Extron Safety and Regulatory Compliance Guide』(P/N 68-290-01) をご覧ください。

## 안전 지침 · 한국어

**경고:** 이 기호 ⚠ 가 제품에 사용될 경우, 제품의 인클로저 내에 있는 접지되지 않은 위험한 전류로 인해 사용자가 감전될 위험이 있음을 경고합니다.

**주의:** 이 기호 ⚠ 가 제품에 사용될 경우, 장비와 함께 제공된 책자에 나와 있는 주요 운영 및 유지보수(정비) 지침을 경고합니다.

안전 가이드라인, 규제 준수, EMI/EMF 호환성, 접근성, 그리고 관련 항목에 대한 자세한 내용은 Extron 웹 사이트([www.extron.com](http://www.extron.com))의 Extron 안전 및 규제 준수 안내서, 68-290-01 조항을 참조하십시오.

## Copyright

© 2014-2019 Extron Electronics. All rights reserved. [www.extron.com](http://www.extron.com)

## Trademarks

All trademarks mentioned in this guide are the properties of their respective owners.

The following registered trademarks (®), registered service marks (SM), and trademarks (TM) are the property of RGB Systems, Inc. or Extron Electronics (see the current list of trademarks on the [Terms of Use](#) page at [www.extron.com](http://www.extron.com)):

### Registered Trademarks (®)

Extron, Cable Cubby, ControlScript, CrossPoint, DTP, eBUS, EDID Manager, EDID Minder, Flat Field, FlexOS, Glitch Free, Global Configurator, Global Scriptor, GlobalViewer, Hideaway, HyperLane, IP Intercom, IP Link, Key Minder, LinkLicense, LockIt, MediaLink, MediaPort, NetPA, PlenumVault, PoleVault, PowerCage, PURE3, Quantum, Show Me, SoundField, SpeedMount, SpeedSwitch, StudioStation, System *INTEGRATOR*, TeamWork, TouchLink, V-Lock, VideoLounge, VN-Matrix, VoiceLift, WallVault, WindoWall, XTP, XTP Systems, and ZipClip

**Registered Service Mark (SM) :** S3 Service Support Solutions

### Trademarks (TM)

AAP, AFL (Accu-Rate Frame Lock), ADSP (Advanced Digital Sync Processing), Auto-Image, CableCover, CDRS (Class D Ripple Suppression), Codec Connect, DDSP (Digital Display Sync Processing), DMI (Dynamic Motion Interpolation), Driver Configurator, DSP Configurator, DSVP (Digital Sync Validation Processing), eLink, EQIP, Everlast, FastBite, FOX, FOXBOX, IP Intercom HelpDesk, MAAP, MicroDigital, Opti-Torque, PendantConnect, ProDSP, QS-FPC (QuickSwitch Front Panel Controller), Room Agent, Scope-Trigger, ShareLink, SIS, Simple Instruction Set, Skew-Free, SpeedNav, Triple-Action Switching, True4K, Vector™ 4K, WebShare, XTRA, and ZipCaddy

## FCC Class A Notice

This equipment has been tested and found to comply with the limits for a Class A digital device, pursuant to part 15 of the FCC rules. The Class A limits provide reasonable protection against harmful interference when the equipment is operated in a commercial environment. This equipment generates, uses, and can radiate radio frequency energy and, if not installed and used in accordance with the instruction manual, may cause harmful interference to radio communications. Operation of this equipment in a residential area is likely to cause interference. This interference must be corrected at the expense of the user.

### ATTENTION:

- The Twisted Pair Extension technology works with unshielded twisted pair (UTP) or shielded twisted pair (STP) cables; **but to ensure FCC Class A and CE compliance, STP cables and STP Connectors are required.**
- La technologie extension paires torsadées fonctionne avec les câbles paires torsadées blindées (UTP) ou non blindées (STP). Afin de s'assurer de la compatibilité entre FCC Classe A et CE, les câbles STP et les connecteurs STP sont nécessaires.

### NOTES:

- This unit was tested with shielded I/O cables on the peripheral devices. Shielded cables must be used to ensure compliance with FCC emissions limits.
- For more information on safety guidelines, regulatory compliances, EMI/EMF compatibility, accessibility, and related topics, see the **Extron Safety and Regulatory Compliance Guide** on the Extron website.

## Conventions Used in this Guide

### Notifications

The following notifications are used in this guide:

### ATTENTION:

- Risk of property damage.
- Risque de dommages matériels.

**NOTE:** A note draws attention to important information.

## Specifications Availability

Product specifications are available on the Extron website, [www.extron.com](http://www.extron.com).

## Extron Glossary of Terms

A glossary of terms is available at <http://www.extron.com/technology/glossary.aspx>.

# Contents

---

## **Introduction ..... 1**

About this Guide.....	1
About the DTP T/R DP 4K 330 and DTP T/R DP 4K 230 Extenders.....	1
TP Cable Advantages.....	1
Features.....	2

---

## **Installation and Operation ..... 3**

Rear Panel Connections and Features.....	3
Transmitter Connections and Switch.....	4
Receiver Connections.....	6
Connector and Cable Details.....	7
Front Panel Connection and Power Indicator....	11
Operation.....	11
Use and Compatibility with Other Extron DTP Products.....	11

---

## **Remote Control ..... 12**

Simple Instruction Set Control.....	12
Host-to-Receiver Communications.....	12
Receiver-Initiated Message.....	12
Error responses.....	12
Timeout.....	12
Using the Command and Response Table....	13
Product Configuration Software.....	14
Installing the Software.....	14
Starting the Program.....	17
Updating the Firmware.....	18

---

## **Equipment Mounting ..... 22**

Mounting the Transmitter or Receiver.....	22
Tabletop Use.....	22
Mounting kits.....	22
UL Rack-Mounting Guidelines.....	22



# Introduction

- [About this Guide](#)
- [About the DTP T/R DP 4K 330 and DTP T/R DP 4K 230 Extenders](#)
- [TP Cable Advantages](#)
- [Features](#)

## About this Guide

This guide describes the Extron DisplayPort Twisted Pair Extenders. This guide covers two Extender models:

- **DTP T/R DP 4K 330** — Consists of a DTP T DP 4K 330 transmitter and a DTP R DP 4K 330 receiver.
- **DTP T/R DP 4K 230** — Consists of a DTP T DP 4K 230 transmitter and a DTP R DP 4K 230 receiver.

This guide describes how to install, operate, and configure the transmitters and receivers.

## About the DTP T/R DP 4K 330 and DTP T/R DP 4K 230 Extenders

The Extron DTP T/R DP 4K transmitter and receiver pair (see [figure 1](#) on the next page) are twisted pair Extender sets for transmission of:

- HDCP-compliant DisplayPort video (which can include embedded digital audio)
- Optional analog audio
- RS-232 and IR control signals

**NOTE:** The RS-232 and IR communications are a passive pass-through only. The transmitter and receiver do not generate or respond to the RS-232 and IR communication signals.

Transmission is over one Extron XTP DTP 24 shielded twisted pair (STP) cable (recommended) or Category (CAT) 5e or CAT 6 STP cable. The two models are similar except for the transmission range:

- **DTP T/R DP 4K 330** — Up to 330 feet (100 m)
- **DTP T/R DP 4K 230** — Up to 230 feet (70 m)

## TP Cable Advantages

Twisted pair cable is much smaller, lighter, more flexible, and less expensive than coaxial or HDMI cable. These transmitter and receiver twisted pair (TP) products make cable runs simpler and less cumbersome. Termination of the cable with RJ-45 connectors is simple, quick, and economical.

**NOTE:** Do **not** use Extron UTP23SF-4 Enhanced Skew-Free AV UTP cable or STP201 cable to link the transmitter and receiver. The DTP DP transmitter and receiver do not work properly with these cables.

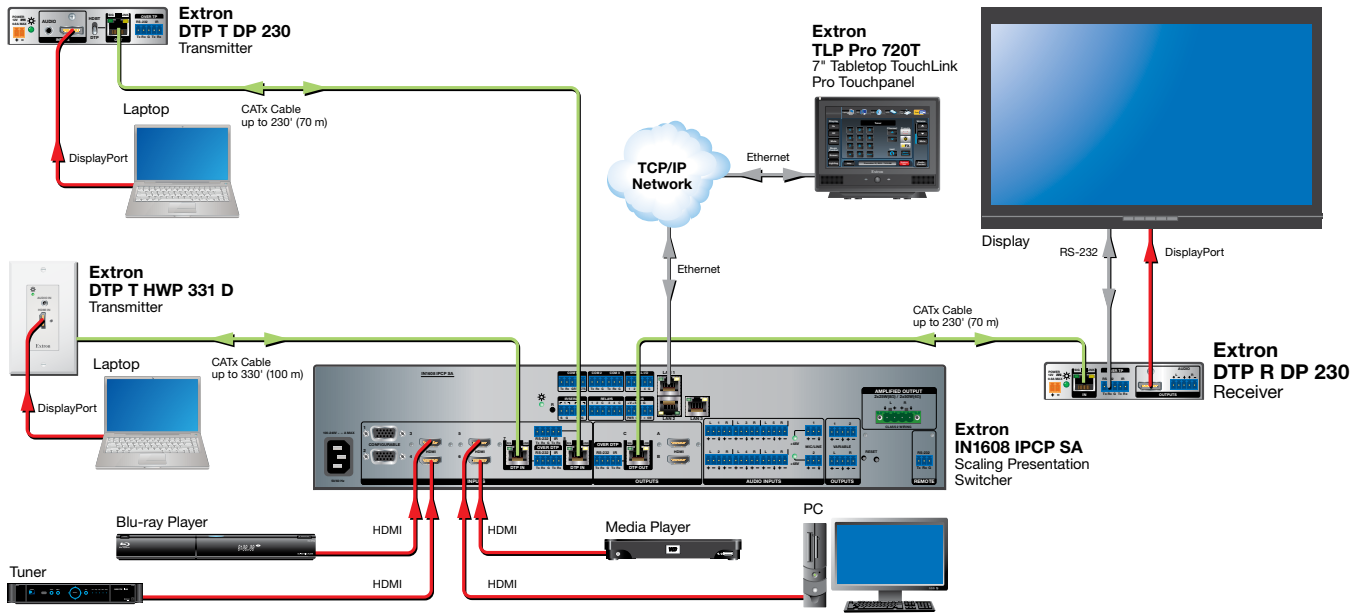

**Figure 1. Typical DTP T/R DP 4K 230 Transmitter and Receiver Application in a System with an IN1608**

## Features

### **Transmits DisplayPort video, control, and analog audio over a single STP cable**

Standard twisted pair cables provide an economical, easily installed cable solution.

**Long distance transmission** — Extends video, audio, and control signals up to 330 feet (100 meters) (DTP T/R DP 4K 330) or 230 feet (70 meters) (DTP T/R DP 4K 230).

**The DTP transmitter is compatible with HDBaseT-enabled devices** — The DTP transmitter can be configured to send video and embedded audio, plus bidirectional RS-232 and IR signals to HDBaseT-enabled displays.

**Supports Display Data Channel (DDC) transmission** — The transmitter and receiver pair fully supports long distance transmission of the DDC signals.

### **HDCP compliant**

**Control communications pass-through** — Bidirectional RS-232 and IR control signals can be transmitted alongside the digital video signal, so that the remote display can be controlled without the need for additional cabling.

**Supports computer video up to 2560x1600, HDTV 1080p/60 Deep Color, and 4K resolutions**

**1-inch high, quarter rack width, metal enclosures** — With low profile enclosures, the transmitter and receiver can be discreetly installed in locations such as behind a plasma or LCD flat-panel display.

**External 100 VAC to 240 VAC, 50-60 Hz, international power supply** — One power supply is included with the transmitter.

**Remote powering of transmitter or receiver** — Only one power supply is normally necessary to power both devices.

**Compatible with all DTP HDMI 330 (230) and DTP DVI 330 (230) receivers, and DTP 330- (230)-enabled products** — The Extenders can be used with the Extron IN1608, DTP CrossPoint 84, and other DTP 330- (230)-enabled products to meet application requirements.

# Installation and Operation

This section describes the installation and the operation of the DTP T/R DP 4K Extenders, including:

- [Rear Panel Connections and Features](#)
- [Front Panel Connection and Power Indicators](#)
- [Operation](#)

**NOTE:** For equipment mounting, see [Mounting the Transmitter or Receiver](#) on page 23.

## Rear Panel Connections and Features

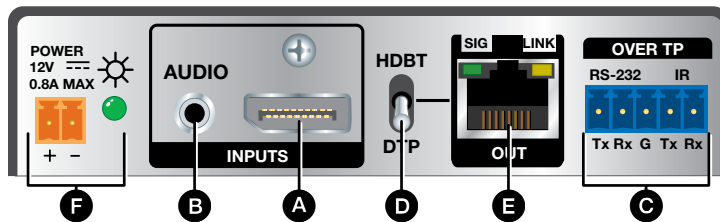

**Figure 2.** DTP T DP 4K 330 and DTP T DP 4K 230 Rear Panel Connectors and Switch

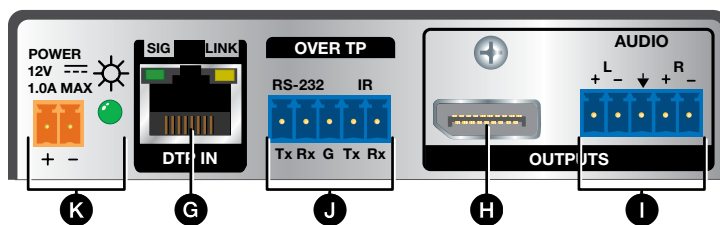

**Figure 3.** DTP R DP 4K 330 and DTP R DP 4K 230 Rear Panel Connectors



### Transmitter Features

- A** DisplayPort input port (see [page 4](#))
- B** Audio input port (see [page 4](#))
- C** Over TP port (see [page 4](#))
- D** TP function switch (see [page 4](#))
- E** TP Out port (see [page 5](#))
- F** Power connector and LED (see [page 5](#))

### Receiver Features

- G** DTP Input port (see [page 6](#))
- H** DisplayPort Output port (see [page 6](#))
- I** Audio Output port (see [page 6](#))
- J** Over TP port (see [page 6](#))
- K** Power connector and LED (see [page 7](#))

## Transmitter Connections and Switch

- A DisplayPort input port** (see [figure 2](#) on the previous page) — Connect a digital video input to this DisplayPort connector. The transmitters also accept embedded digital audio on this port. 
- B Audio input connector** — If desired, plug an analog audio input into the transmitter via this stereo mini jack connector. 

### NOTES:

- The analog audio input on this connector is **not** embedded into the digital signal and is in addition to the digital audio that may be already embedded in the DisplayPort input.
- See figure 4 to identify the connector tip, ring, and sleeve when you are making connections for the transmitter from existing audio cables. A mono audio connector consists of the tip and sleeve. A stereo audio connector consists of the tip, ring, and sleeve.

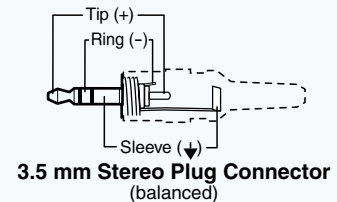

**Figure 4. TRS Connector Wiring**

- C Over TP RS-232 and IR connector** — Connect a serial RS-232 signal, a modulated IR signal, or both to this 3.5 mm, 5-pole captive screw connector for bidirectional RS-232 and IR communication (see [RS-232 and IR connector wiring](#) on page 10 to wire the connector).

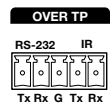

- D TP function switch** — If the receiving device is in the Extron DTP series, set this switch to the DTP position. For an HDBaseT-enabled receiver type, set this switch to the HDBT position. This switch tailors the output signal as follows:



**HDBT position** — The TP output consists of DisplayPort video with embedded digital audio plus RS-232 and IR.

**DTP position** — The TP output consists of DisplayPort video with embedded digital audio, analog audio, RS-232 and IR, and remote power.

### ATTENTION:

- Position this switch **BEFORE** connecting the appropriate device to the TP connector. Failure to comply can damage the endpoint.
- Positionnez le sélecteur **AVANT** de connecter l'appareil approprié au connecteur TP. Ne pas respecter cette procédure pourrait endommager le point de connexion.

### NOTES:

- When the switch is in the HDBT position**, the transmitter and receiver each requires a local 12 VDC power supply.
- When the switch is in the DTP position**, one 12 VDC power supply, connected to either the transmitter or the receiver, can power both units.

- E TP Output RJ-45 connector** (see [figure 2](#) on page 3) — Connect one end of a TP cable to this RJ-45 female connector on the transmitter. Ensure the opposite end of this cable is connected to the receiver TP Input RJ-45 connector (see item **G**, below).

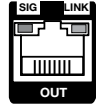

**ATTENTION:**

- Do not connect these devices to a telecommunications or computer data network.
- Ne connectez pas ces appareils à des données informatiques ou à un réseau de télécommunications.

**NOTE:** See [TP cable termination and recommendations](#) on page 7 to properly wire the RJ-45 connectors and for detailed **NOTES**.

**Signal LED** — Indicates the unit is receiving a DisplayPort signal on the DisplayPort input.

**Link LED** — Indicates a valid link is established between the units on the DTP input and output cable.

- F Power connector** — Plug the included external 12 VDC power supply into either this 2-pole connector **or** the power input connector on the receiver (see [item K](#) on page 7).

**ATTENTION:**

- Do not connect power to the DTP T/R DP 4K 330 or DTP T/R DP 4K 230 until you have read the **CAUTION** and **ATTENTION** notices on pages 9 and 10.
- Ne branchez pas l'alimentation au DTP T/R DP 4K 330 ou DTP T/R DP 4K 230 avant d'avoir lu les deux rubriques « **ATTENTION** » aux pages 9 et 10.

**NOTE:** When the TP function switch (see [item D](#) on page 4) is in the **DTP position**, one power supply can power both units.

When the TP function switch is in the **HDBT position**, the transmitter and receiver each requires a local 12 VDC power supply.

**Power LED** —

**Amber** — The unit is receiving power remotely (on the DTP cable).

**Green** — The unit is receiving power locally.

## Receiver Connections

- G DTP Input RJ-45 connector** (see [figure 3](#) on page 3) — Connect one end of the TP cable from the transmitter output connector to this RJ-45 female connector. Ensure the opposite end of this cable is connected to the transmitter DTP Output RJ-45 connector (see [item E](#), on the previous page).

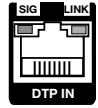

### ATTENTION:

- Do not connect these devices to a telecommunications or computer data network.
- Ne connectez pas ces appareils à des données informatiques ou à un réseau de télécommunications.

**NOTE:** See [TP cable termination and recommendations](#) on page 7 to properly wire the RJ-45 connectors and for detailed **NOTES**.

**Signal LED** — Indicates the unit is receiving a valid signal on the DTP In connector.

**Link LED** — Indicates a valid link is established between the units on the DTP input and output cable.

- H DisplayPort output connector** — Connect a video display to this DisplayPort connector.



- I Audio output connector** — This 5-pole, 3.5 mm captive screw connector outputs the transmitted, unamplified, line level analog audio. Connect an audio device, such as an audio amplifier or powered speakers.

See figure 5 to properly wire a captive screw output connector. Use the supplied tie-wrap to strap the audio cable to the extended tail of the connector.

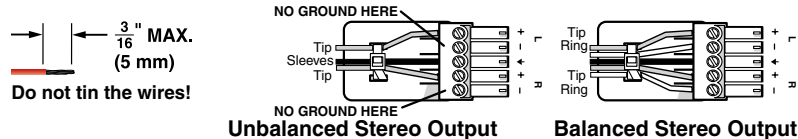

**Figure 5. Captive Screw Connector Wiring for Stereo Audio Output**

### ATTENTION:

- For unbalanced audio, connect the sleeves to the ground contact. **DO NOT** connect the sleeves to the negative (-) contacts.
- Pour l'audio asymétrique, connectez les manchons au contact au sol. Ne **PAS** connecter les manchons aux contacts négatifs (-).

### NOTES:

- The length of exposed wires is important. The ideal length is 3/16 inch (5 mm).
- If the stripped section of wire is longer than 3/16 inch, the exposed wires may touch, causing a short circuit.
- If the stripped section of wire is shorter than 3/16 inch, wires can be easily pulled out even if tightly fastened by the captive screws.
- Do not tin the power supply leads before installing them in the connector. Tinned wires are not as secure in the connector and could be pulled out.

- J Over TP RS-232 and IR connector** — Connect a serial RS-232 signal, a modulated IR signal, or both to this 3.5 mm, 5-pole captive screw connector for bidirectional RS-232 and IR communication (see [RS-232 and IR connector wiring](#) on page 10 to wire the connector).

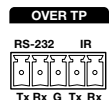

- K Power input connector** (see **figure 3** on page 3) — Plug the included external 12 VDC power supply into either this 2-pole connector **or** the power input connector on the transmitter (see **item F** on the previous page).

**ATTENTION:**

- Do not connect power to the DTP T/R DP 4K 330 or DTP T/R DP 4K 230 until you have read the **CAUTION** and **ATTENTION** notices on pages 9 and 10.
- Ne branchez pas l'alimentation au DTP T/R DP 4K 330 ou DTP T/R DP 4K 230 avant d'avoir lu les deux rubriques « **ATTENTION** » aux pages 9 et 10.

**NOTE:** When the TP function switch (see **item D** on page 4) is in the **DTP position**, one power supply can power both units.

When the TP function switch is in the **HDBT position**, the transmitter and receiver each requires a local 12 VDC power supply.

**Power LED** —

**Amber** — The unit is receiving power remotely (on the DTP cable).

**Green** — The unit is receiving power locally.

## Connector and Cable Details

### TP cable termination and recommendations

Figure 6 details the **TIA/EIA T568-B** wiring standard. Use this standard to terminate TP cables with RJ-45 connectors.

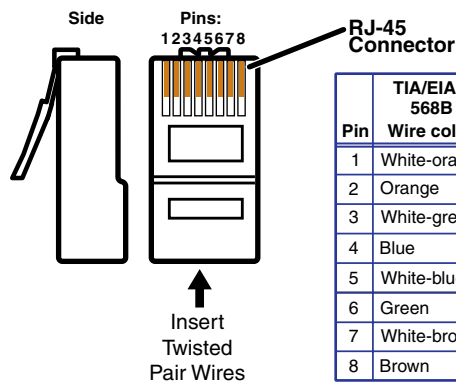

**Figure 6. TP Cable Termination**

**NOTE:** Do **not** use Extron UTP23SF-4 Enhanced Skew-Free AV UTP cable or STP201 cable to link the transmitter and receiver. The DTP DisplayPort units do not work properly with these cables.

**Supported cables** —

The DTP T/R DP 4K 330 and DTP T/R DP 4K 230 are compatible with shielded twisted pair (STP) and unshielded twisted pair (U/UTP) cable. However, Extron strongly recommends that you use STP cable to achieve best performance.

### Cable recommendations —

Extron recommends using the following practices to achieve full transmission distances up to 330 feet (100 m) (DTP T/R DP 330) or 230 feet (70 m) (DTP T/R DP 230) and reduce transmission errors.

- Use the following Extron XTP DTP 24 SF/UTP cables and DTP 24 connectors for the best performance:
  - **XTP DTP 24/1000** Non-Plenum 1000' (305 m) spool 22-236-03
  - **XTP DTP 24P/1000** Plenum 1000' (305 m) spool 22-235-03
  - **XTP DTP 24 Plug** Package of 10 101-005-02
- If not using XTP DTP 24 cable, at a minimum, Extron recommends 24 AWG, solid conductor, STP cable with a minimum bandwidth of 400 MHz.
- Terminate cables with shielded connectors to the TIA/EIA T 568 B standard.
- Use no more than two pass-through points, which may include patch points, punch down connectors, couplers, and power injectors. If these pass-through points are required, use CAT 6 or 6a shielded couplers and punch down connectors.

**NOTE:** When using STP cable in bundles or conduits, consider the following:

- Do not exceed 40% fill capacity in conduits.
- Do not comb the cable for the first 20 meters, where cables are straightened, aligned, and secured in tight bundles.
- Loosely place cables and limit the use of tie wraps or Velcro®.
- Separate twisted pair cables from AC power cables.

## Power supply wiring

**NOTE:** One power supply is included with the transmitter and **normally** can power both units.

Figure 7 shows how to wire the connector. Use the supplied tie-wrap to strap the power cord to the extended tail of the connector.

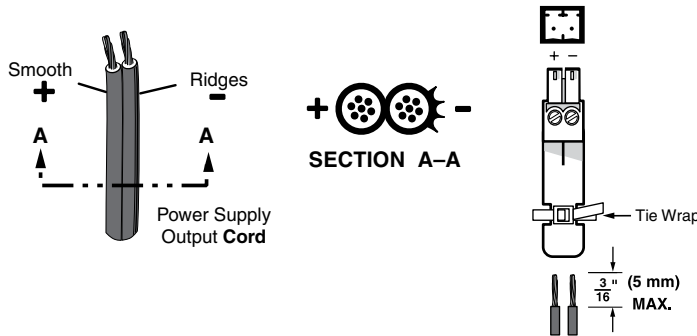

**Figure 7. Power Connector Wiring**

### **CAUTION:**

#### **ATTENTION :**

- The wires must be kept separate while the power supply is plugged in. Remove power before wiring.
- Les deux cordons d'alimentation doivent être tenus à l'écart l'un de l'autre quand l'alimentation est branchée. Couper l'alimentation avant de faire l'installation électrique.
- The length of exposed wires is important. The ideal length is 3/16 inch (5 mm).
  - Any longer and the exposed wires may touch, causing a short circuit.
  - Any shorter and the wires can be easily pulled out even if tightly fastened by the captive screws.
- La longueur des câbles exposés est importante. La longueur idéale est de 5 mm (3/16 inches).
  - S'ils sont un peu plus longs, les câbles exposés pourraient se toucher et provoquer un court circuit.
  - S'ils sont un peu plus courts, ils pourraient sortir, même s'ils sont attachés par les vis captives.
- Do not tin the power supply leads before installing them in the connector. Tinned wires are not as secure in the connector and could be pulled out.
- Ne pas étamer les conducteurs avant de les insérer dans le connecteur. Les câbles étamés ne sont pas aussi bien fixés dans le connecteur et pourraient être retirés.

### ATTENTION:

- This product is intended to be supplied by a UL Listed power source marked “Class 2” or “LPS,” rated 12 VDC, 1.0 A minimum. Always use a power supply supplied by or specified by Extron. Use of an unauthorized power supply voids all regulatory compliance certification and may cause damage to the supply and the end product.
- Ce produit est destiné à une utilisation avec une source d’alimentation listée UL avec l’appellation « Classe 2 » ou « LPS » et normée 12 Vcc, 1,0 A minimum. Utilisez toujours une source d’alimentation fournie ou recommandée par Extron. L’utilisation d’une source d’alimentation non autorisée annule toute conformité réglementaire et peut endommager la source d’alimentation ainsi que le produit final.
- Unless otherwise stated, the AC/DC adapters are not suitable for use in air handling spaces or in wall cavities.
- Sauf mention contraire, les adaptateurs AC/DC ne sont pas appropriés pour une utilisation dans les espaces d’aération ou dans les cavités murales.
- The installation must always be in accordance with the applicable provisions of National Electrical Code ANSI/NFPA 70, article 725 and the Canadian Electrical Code part 1, section 16. The power supply shall not be permanently fixed to a building structure or similar structure.
- Cette installation doit toujours être en accord avec les mesures qui s’applique au National Electrical Code ANSI/NFPA 70, article 725, et au Canadian Electrical Code, partie 1, section 16. La source d’alimentation ne devra pas être fixée de façon permanente à une structure de bâtiment ou à une structure similaire.
- Power supply voltage polarity is critical. Incorrect voltage polarity can damage the power supply and the unit. The ridges on the side of the cord (see [figure 7](#) on the previous page) identify the power cord negative lead.
- La polarité de la source d’alimentation est primordiale. Une polarité incorrecte pourrait endommager la source d’alimentation et l’unité. Les stries sur le côté du cordon (voir [l’illustration 7](#) sur la page 9) permettent de repérer le pôle négatif du cordon d’alimentation.

To verify the polarity before connection, plug in the power supply with no load and check the output with a voltmeter.

### RS-232 and IR connector wiring

Figure 8 shows how to wire the RS-232 connector.

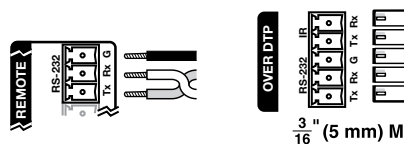
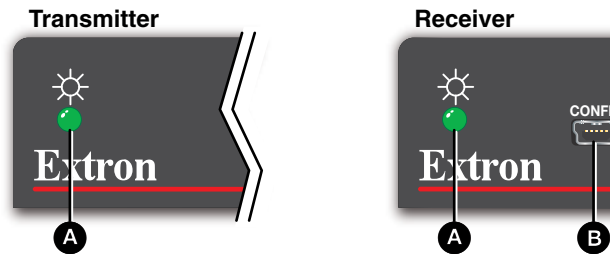

Figure 8. RS-232 Connector Wiring

### NOTES:

- The IR Tx and Rx line pair and the RS-232 Tx and Rx line pair must each cross once between this connector and the source or destination.
- The length and preparation of exposed wires is important (see the audio connector [NOTES](#) on page 6 for details).

## Front Panel Connection and Power Indicator



**Figure 9. Transmitter and Receiver Front Panel Connector and Indicator**

- A Power (and signal) LED** (both units) —
  - Amber** — The unit is receiving power, either locally or remotely (on the DTP cable).
  - Green** — The unit is powered and is receiving an active digital input, either on the DisplayPort input if a transmitter, or transmitted on the DTP cable if a receiver.
- B Configuration port** (receiver only) — This USB mini-B port is used to configure video and EDID settings and to update firmware.

## Operation

After the transmitter, the receiver, and their connected devices are powered up, the system is fully operational. If any problems are encountered, ensure all cables are routed and connected properly.

**NOTE:** Ensure that the video source and display selected for the DDC are properly connected to the transmitter and receiver pair, and that the transmitter, the receiver, and the display have power applied **before** power is applied to the video source. If the other devices are not turned on before the video source, the image may not appear.

## Use and Compatibility with Other Extron DTP Products

The Extenders are compatible with the full line of Extron DTP products. When they are used with DTP 330 and DTP 230 HDMI and DVI transmitters or receivers:

- The supported pixel clock rate is up to 300 Mhz.
- The supported resolutions are up to 3840x2160 @ 30 Hz or 4096x2160 @ 30 Hz with multi-channel audio.

The Extenders can also be used with presentation switchers such as the MPS 602 or the IN1608, but the pixel clock rate is limited to 165 Mhz.

**NOTE:** Some older DP sources do not support audio. Audio on these older sources is not supported when DTP 330 or DTP 230 DP transmitters are used with DTP 330 or DTP 230 HDMI receivers.

# Remote Control

The DTP R DP 4K 330 and DTP R DP 4K 230 receivers can be remotely controlled using either Extron SIS commands or Product Configuration Software from a host device such as a computer or control system via their front panel configuration (USB) ports (see [item B](#) on the previous page).

This section includes:

- [Simple Instruction Set Control](#)
- [Product Configuration Software](#)

## Simple Instruction Set Control

### Host-to-Receiver Communications

SIS commands consist of one or more characters per field. No special characters are required to begin or end a command character sequence. When a command is valid, the receiver executes the command and sends a response to the host device. All responses from the receiver to the host end with a carriage return and a line feed (CR/LF = **↵**), which signals the end of the response character string. A string is one or more characters.

### Receiver-Initiated Message

When power is applied, the receiver responds by sending the following copyright message to the host:

© Copyright 20yy, Extron Electronics DTP R DTP 4K 230/330, Vx.xx, 60-nnnn-nn↵

Vx.xx is the firmware version number and 60-nnnn-nn is the part number.

### Error responses

When the receiver receives a valid SIS command, it executes the command and sends a response to the host device. If the receiver is unable to execute the command because the command is invalid or it contains invalid parameters, the receiver returns an error response to the host. The error response codes are:

E10 — Invalid command

E13 — Invalid parameter

### Timeout

Pauses of 10 seconds or longer between command ASCII characters result in a timeout. The command operation is aborted with no other indication.



## Command and Response Table for SIS Commands (continued)

Command Function	SIS Command (Host to Unit)	Response (Unit to Host)	Additional description
<b>Unit name</b>			
Set unit name	<code>[Esc]X4CN←</code>	<code>Ipn•X4↵</code>	Set unit name to X4.
Set unit name to factory default	<code>[Esc]•CN←</code>	<code>Ipn•DTP-R-DP-4K-230↵</code> <code>Ipn•DTP-R-DP-4K-330↵</code>	Unit name depends on model.
Show unit name	<code>[Esc]CN←</code>	<code>X4↵</code>	
<i>Verbose mode 2 and 3:</i>	<code>[Esc]CN←</code>	<code>Ipn•X4↵</code>	
<b>Information requests</b>			
Request part number	N	<code>60-nnnn-nn↵</code>	See <a href="http://www.extron.com">www.extron.com</a> for part numbers.
<i>Verbose mode 2 and 3:</i>	N	<code>Pno•60-nnnn-nn↵</code>	
Query controller firmware version	Q	<code>X7↵</code>	
<i>Example:</i>	Q	<code>1.23↵</code>	The factory-installed controller firmware version is 1.23 ( <i>sample value only</i> ).

## Product Configuration Software

This section details the Extron Product Configuration Software (PCS), available on the Extron website. The Windows-based PCS communicates with the unit via the front panel configuration port, a standard USB mini-B port (see [item B](#) on page 11).

### Installing the Software

PCS and Firmware Loader are available on the Extron website. Download and install both programs as follows:

#### NOTES:

- This procedural description is illustrated as using Internet Explorer. Depending on the browser you use, some steps or indications may be different.
- Steps 1 through 7, below, are also used to download firmware update packages.

1. Go to [www.extron.com](http://www.extron.com) and click the **Download** tab (see figure 10, **1**).

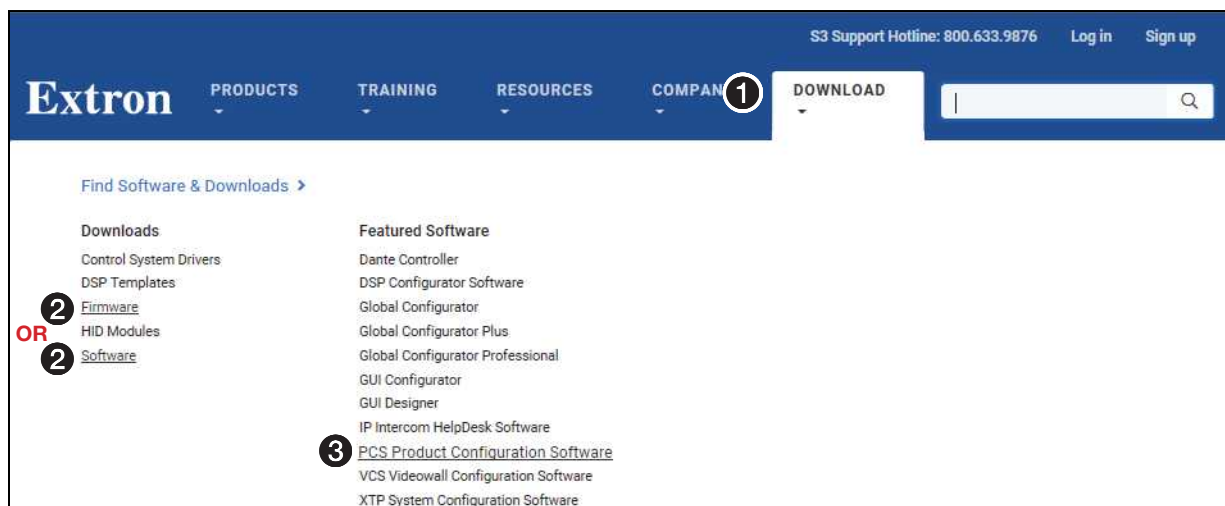

Figure 10. Selecting the Download Tab

2. Click the **Software** or **Firmware** link on the main download page, as appropriate to the operation you are performing (2).

**TIP:** Many popular software downloads, such as the Product Configuration Software, have direct links to their download options on the Web page (3). Click the link to jump directly to information page for that software download (see figure 12 on the next page).

3. Click **Download** for the desired software or firmware to download on either main download page (see figure 11, 1) or the software product information page (see figure 12, 1).

**TIP:** On the main download page, jump to the nearest page of downloads by clicking the desired filtering letter (see figure 11, 2).

The Log in dialog box appears (see figure 13 on page 17).

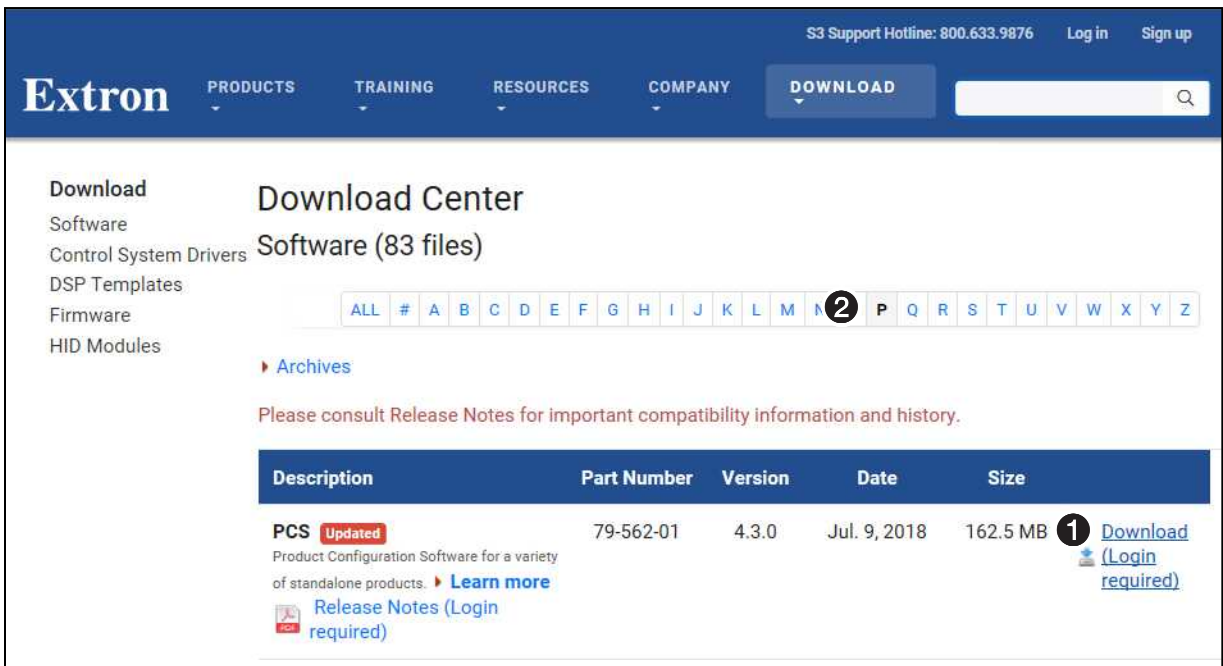

**Figure 11. Downloading from the Main Download Page**



**Figure 12. Downloading from the Product Information Page**

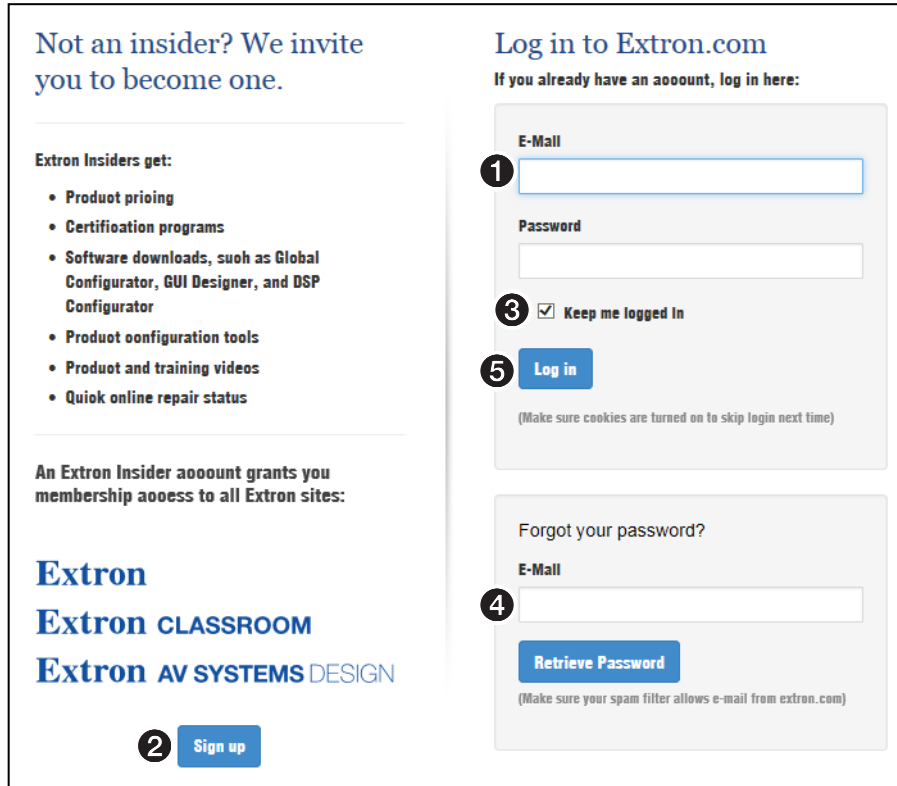

**Figure 13. Log in Dialog Box**

4. Enter the **E-Mail** address and **Password** associated with your Extron insider account (see figure 13, ❶).

**TIPS:**

- Click **Sign up** (❷) to obtain website credentials.
- Click **Keep me logged in** (❸) to eliminate steps 4 and 5 in future downloads.
- Enter your registered email address and click **Retrieve Password** (❹) if you have forgotten your credentials.

5. Click **Log in** to copy the software to the computer (❺).
6. If your browser asks you to confirm that you want to continue, click **Run** or make a similar confirmation that you want to run the installation (see figure 14, ❶).



**Figure 14. Download Warning and Confirmation**

**NOTE:** Figure 12 may appear different or may not appear at all, depending on your Web browser choice and its security settings.

7. For a firmware download, exit this procedure and go to **Updating the Firmware** on page 18.

- Follow the on-screen instructions. The installation creates the necessary subfolders of C:\Program Files and the necessary groups. It places the appropriate files into the correct group folders:

**NOTE:** C:\Program Files(x86)\ ... for 64-bit Windows OS.

#### Product Configuration Software —

**NOTE:** These are default directory paths. Users can choose the directory path they want.

- **Folder** — C:\Program Files\Extron\Extron PCS
- **Group folder** — Extron Electronics\Extron Product Configuration Software
  - **Check for Extron PCS Updates**
  - **Extron PCS Help**
  - **Extron Product Configuration Software**
  - **Uninstall Extron Product Configuration Software**

#### Firmware Loader —

- **Folder** — C:\Program Files\Extron\FWLoader
- **Group folder** — Extron Electronics\Firmware Loader
  - **Check for Firmware Loader Updates**
  - **Firmware Loader Help**
  - **Firmware Loader**
  - **Uninstall Firmware Loader**

## Starting the Program

Start the Extron Product Configuration Software as follows:

- Click **Start > Programs > Extron Electronics > Extron Product Configuration Software > Extron Product Configuration Software**.

The Product Configuration Software opens to the Device Discovery screen (see figure 15).

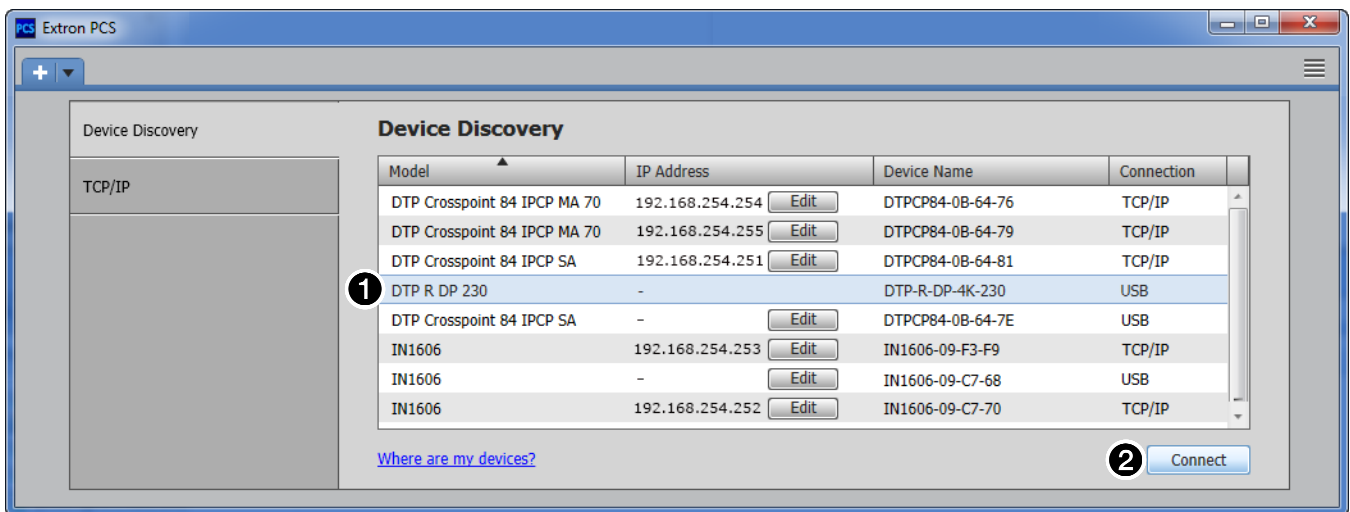
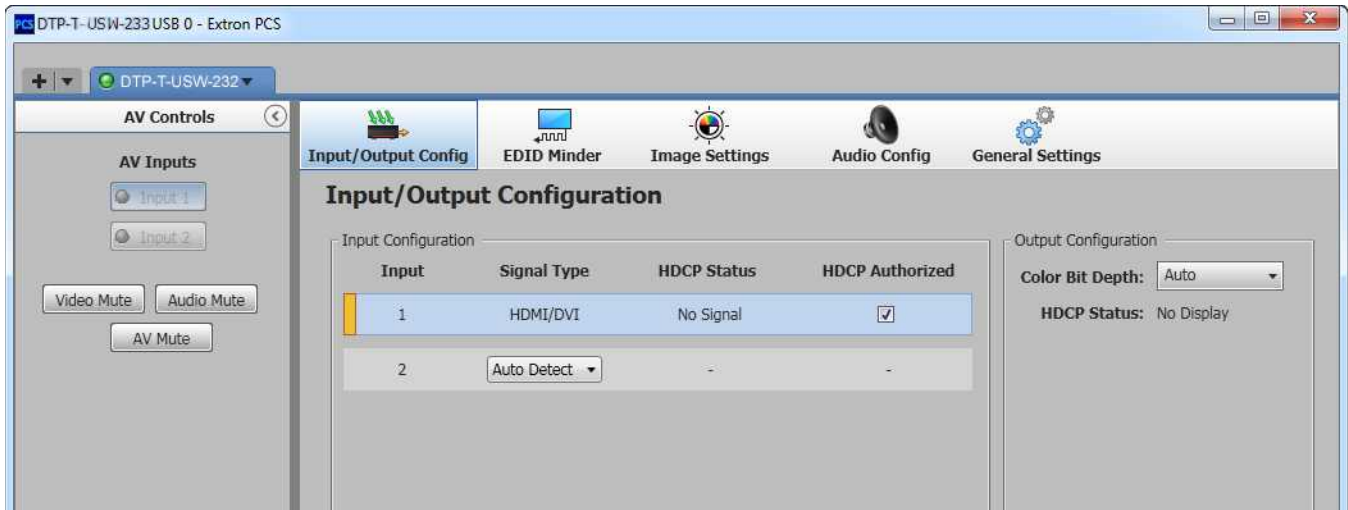

**Figure 15. Device Discovery Screen**

- Select (click) your DTP receiver (see figure 15, **1**).

3. Click **Connect** (see [figure 15](#), **2**, on the previous page). The Product Configuration Software opens to the **Input/Output Configuration** page (see [figure 16](#)).

Operate the Product Configuration Software as described in the PCS Help (click  > **Extron PCS Help**).



**Figure 16. Product Configuration Software**

## Updating the Firmware

The Product Configuration Software can call the Firmware Loader utility, which provides a way to replace the firmware that is coded on the control board of the unit without taking the unit out of service.

Update the unit firmware as follows:

1. Perform steps 1 through 6 of [Installing the Software](#), starting on page 14, to download the firmware upgrade from the Extron [website](#).
2. Click **Run** in the **File Download** and **Security Warning** dialog boxes (see [figure 17](#), **1** on the next page). The PC downloads the firmware update from the Extron website and starts the Extron Installation Program to extract the firmware file.
3. Click **Next** (see **2**). The program extracts the firmware files and places them in a folder identified in the **InstallShield Wizard** window.

### ATTENTION:

- The extension of the firmware file must be .s19. Opening a file with an incorrect extension may cause the device to stop functioning.
- L'extension du fichier firmware doit être .s19. Si un fichier est ouvert avec une mauvaise extension, l'appareil peut arrêter de fonctionner.

### NOTES:

- Note the folder to which the firmware file is saved. When downloaded from the Extron website, the firmware is placed in a subfolder of:
  - 64-bit Windows OS: C:\Program Files (x86)\Extron\Firmware.
  - 32-bit Windows OS: C:\Program Files\Extron\Firmware.
- The original factory-installed firmware is permanently available on the unit. If the attempted firmware upload fails, the unit reverts to the factory-installed firmware.



Figure 17. Extracting Firmware Upgrade Files

4. Click **Finish** to exit the program (figure 17, ③ on the previous page).
5. Connect the computer to the front panel Configuration (USB) port (see item B on page 11) of the receiver.
6. Start the Product Configuration Software and connect to the unit (see **Starting the Program**, beginning on page 17).
7. On the device tab, click  > **Update firmware**.  
The software asks you to confirm that you want to continue the update (see figure 18 on the next page).
8. Click **Continue** (see figure 18, ①). The Product Configuration Software disconnects itself from the unit and calls the Firmware Loader utility in the background. The **Update Firmware** dialog box appears.
9. Click **Browse** (②). The Open dialog box opens.
10. Navigate to the folder where you saved the firmware upgrade file. Select the file (③) and click **Open** (④). The **Update Firmware** dialog box returns to the top.
11. Click **Update** to continue (⑤).  
The Firmware Loader utility tests the connection, installs the update, and then verifies the firmware.
 

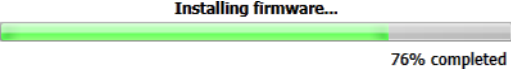

Installing firmware...  
76% completed

At the conclusion of the process, the utility reports **Upload Complete**. 
12. Click **Close**. The Product Configuration Software window returns to the front.
13. Click the in the connection tab to completely disconnect the program from the unit and then reconnect the program as described in **Starting the Program** on page 17.

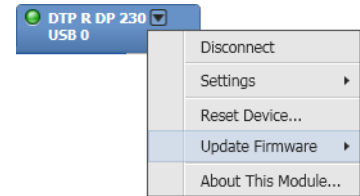

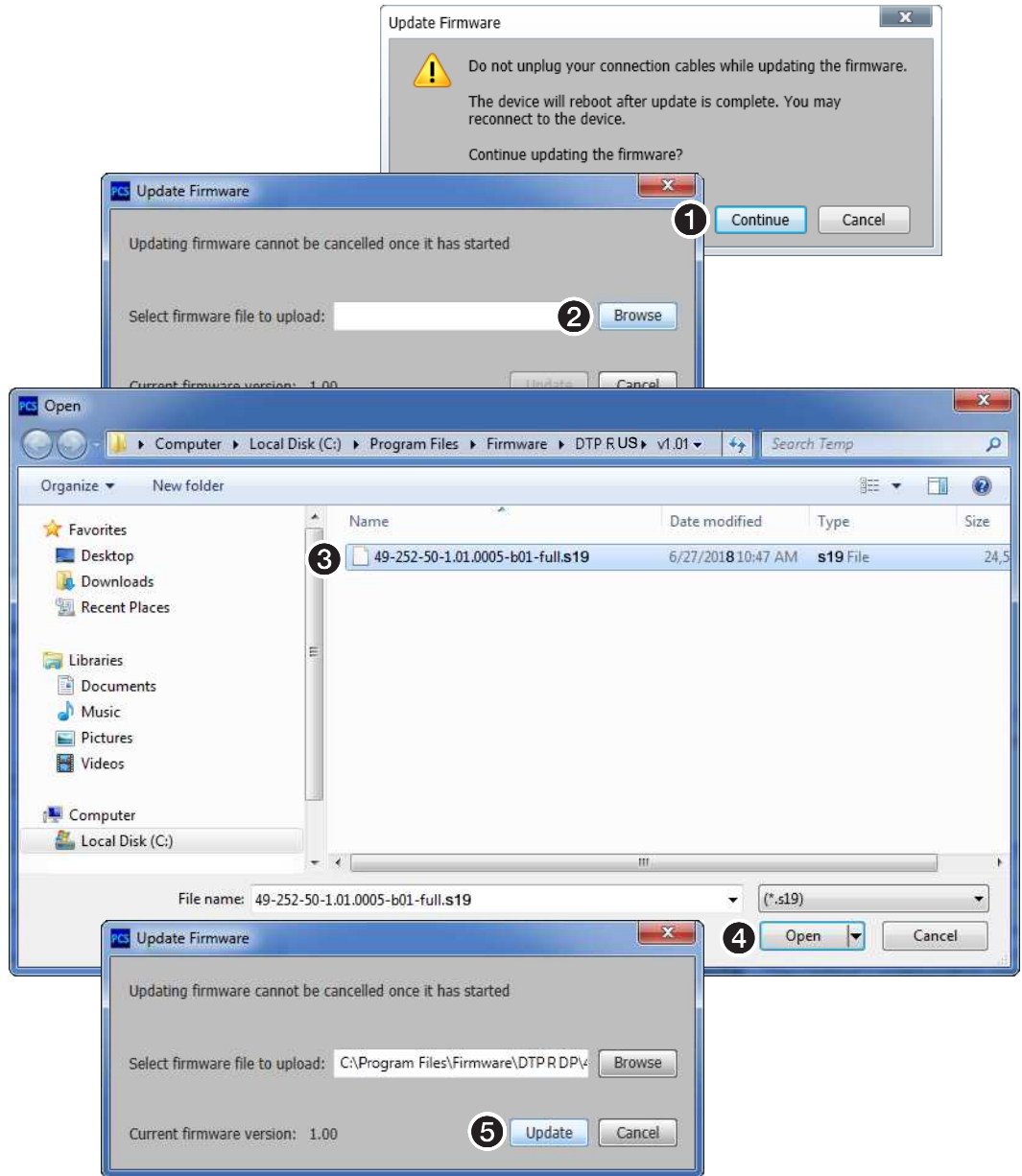

**Figure 18. Updating Firmware**

# Equipment Mounting

This section provides procedures for mounting the DTP T/R DP 4K 330 and DTP T/R DP 4K 230 transmitter and receiver.

## Mounting the Transmitter or Receiver

### ATTENTION:

- Installation and service must be performed by authorized personnel only.
- L'installation et l'entretien doivent être effectués par le personnel autorisé uniquement.

The 1-inch high, quarter rack width transmitter or receiver can be placed on a table, mounted in a rack, or mounted under a desk or table. The receiver can also be mounted on a projector bracket.

### Tabletop Use

Affix the included rubber feet to the bottom of the unit and place it in any convenient location.

### Mounting kits

Mount the unit using any optional compatible mounting kit listed on the Extron website ([www.extron.com](http://www.extron.com)), in accordance with the directions included with the kit. For rack mounting, see “UL Rack-Mounting Guidelines,” below.

### UL Rack-Mounting Guidelines

The following Underwriters Laboratories (UL) requirements pertain to the installation of the unit into a rack.

- **Elevated operating ambient temperature** — If installed in a closed or multi-unit rack assembly, the operating ambient temperature of the rack environment may be greater than room ambient. Therefore, consider installing the equipment in an environment compatible with the maximum ambient temperature (TMA = +122 °F, +50 °C) specified by Extron.
- **Reduced air flow** — Installation of the equipment in a rack should be such that the amount of air flow required for safe operation of the equipment is not compromised.
- **Mechanical loading** — Mounting of the equipment in the rack should be such that a hazardous condition is not achieved due to uneven mechanical loading.
- **Circuit overloading** — Consideration should be given to the connection of the equipment to the supply circuit and the effect that overloading of the circuits might have on overcurrent protection and supply wiring. Appropriate consideration of equipment nameplate ratings should be used when addressing this concern.
- **Reliable earthing (grounding)** — Reliable earthing of rack-mounted equipment should be maintained. Particular attention should be given to supply connections other than direct connections to the branch circuit (such as use of power strips).

# Extron Warranty

Extron Electronics warrants this product against defects in materials and workmanship for a period of three years from the date of purchase. In the event of malfunction during the warranty period attributable directly to faulty workmanship and/or materials, Extron Electronics will, at its option, repair or replace said products or components, to whatever extent it shall deem necessary to restore said product to proper operating condition, provided that it is returned within the warranty period, with proof of purchase and description of malfunction to:

**USA, Canada, South America,  
and Central America:**

Extron Electronics  
1230 South Lewis Street  
Anaheim, CA 92805  
U.S.A.

**Japan:**

Extron Electronics, Japan  
Kyodo Building, 16 Ichibancho  
Chiyoda-ku, Tokyo 102-0082  
Japan

**Europe and Africa:**

Extron Europe  
Hanzeboulevard 10  
3825 PH Amersfoort  
The Netherlands

**China:**

Extron China  
686 Ronghua Road  
Songjiang District  
Shanghai 201611  
China

**Asia:**

Extron Asia Pte Ltd  
135 Joo Seng Road, #04-01  
PM Industrial Bldg.  
Singapore 368363  
Singapore

**Middle East:**

Extron Middle East  
Dubai Airport Free Zone  
F12, PO Box 293666  
United Arab Emirates, Dubai

This Limited Warranty does not apply if the fault has been caused by misuse, improper handling care, electrical or mechanical abuse, abnormal operating conditions, or if modifications were made to the product that were not authorized by Extron.

**NOTE:** If a product is defective, please call Extron and ask for an Application Engineer to receive an RA (Return Authorization) number. This will begin the repair process.

**USA:** 714.491.1500 or 800.633.9876

**Asia:** 65.6383.4400

**Europe:** 31.33.453.4040

**Japan:** 81.3.3511.7655

Units must be returned insured, with shipping charges prepaid. If not insured, you assume the risk of loss or damage during shipment. Returned units must include the serial number and a description of the problem, as well as the name of the person to contact in case there are any questions.

Extron Electronics makes no further warranties either expressed or implied with respect to the product and its quality, performance, merchantability, or fitness for any particular use. In no event will Extron Electronics be liable for direct, indirect, or consequential damages resulting from any defect in this product even if Extron Electronics has been advised of such damage.

Please note that laws vary from state to state and country to country, and that some provisions of this warranty may not apply to you.